

Air breather filter Pi 0201

1. Features

Filter for ventilating and bleeding mobile and stationary hydraulic tanks

The air breather filter Pi 0201 with preloaded valves are used for tanks which are under excess pressure or partial vacuum alternately. The air can flow in and out in a defined manner.

The preloaded valve for inflowing air ensures that a certain partial vacuum is maintained in the container or tank. The air is delayed in flowing in from the outside, the foaming effect is reduced.

The preloaded valve for the outflowing air has been designed to keep a certain excess pressure in the tank for a short time. This reduces the number of air exchanges with the environment. As a result, the service life of the filter cartridge is significantly increased. The excess pressure in the tank has a positive impact on the performance of the downstream pumps, thus enhancing the service life and efficiency of the pumps.

The Pi 0201 is also available in the version with Mol-elements. The Mol-elements prevent the oil mist from emerging. This can be produced by the fast two-way volume flows of the oil. With outflowing air, the oil mist is precipitated in the element. With inflowing air, the oil mist flows from the element back into the tank.

- Compact, sturdy and quickly changeable disposable plastic filter
- Different filter materials for optimum adaptation to customer requirements
- Long service lives thanks to high dirt holding capacity
- Optional separation of oil mist using FGC Mol-elements.
- Filter version with inlet and outlet valve available
- Versions with different connection threads available
- Individual marking possible
- Ergonomic design
- Worldwide distribution



2. Performance curves complete filter

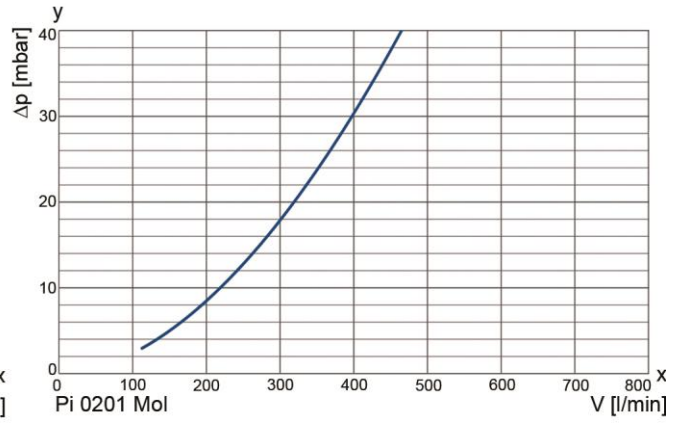
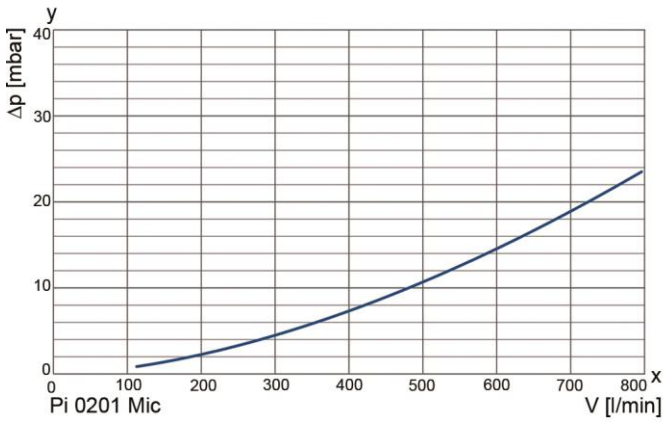
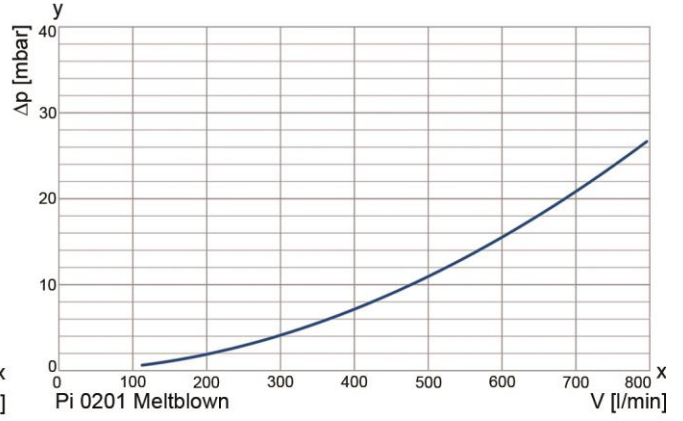
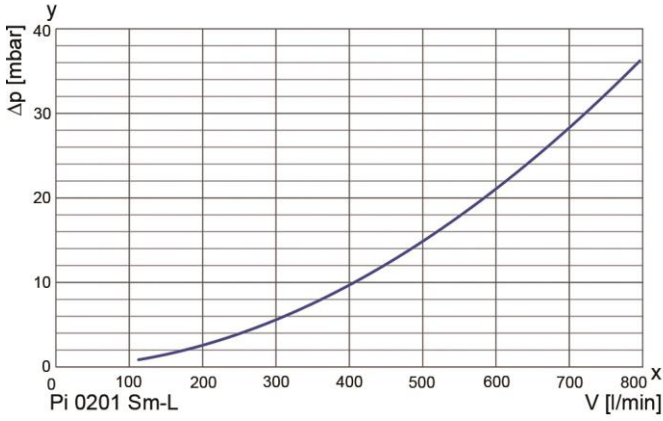

y = differential pressure Δp [mbar]
 x = flow rate V [l/min]

3. Curve showing degree of separation

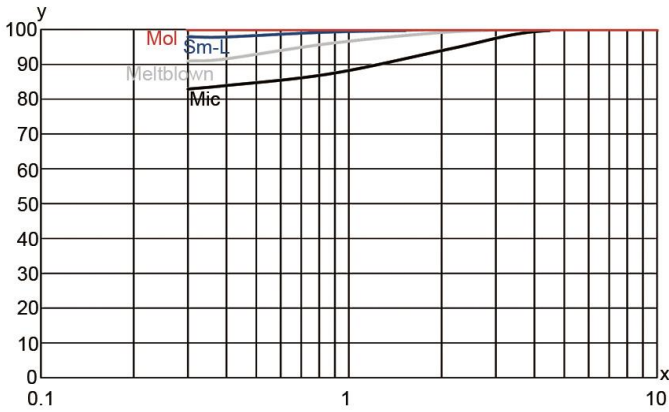

x = particle size n [μm]
 y = degree of separation η [%]

4. Dimensions

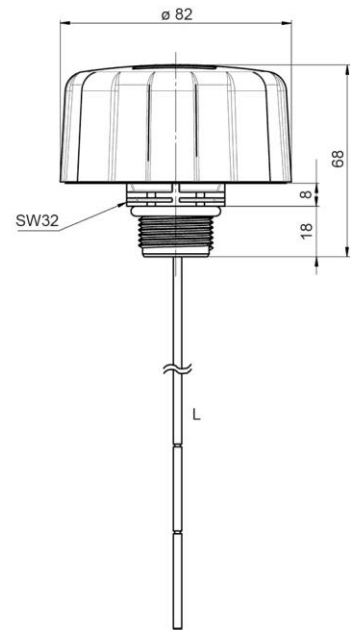
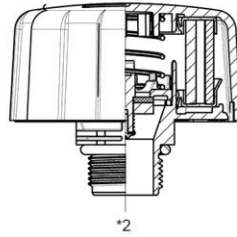
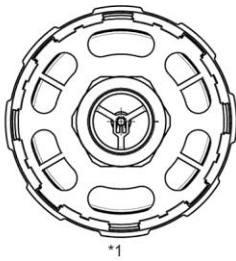

*1 = version G 3/4 with dipstick
 *2 = version G 3/4 with view inlet and outlet valve, Mol-element
 L = length of dipstick optional

5. Technical data

Temperature range: -30 °C to +100 °C
 (other temperature ranges on request)

Housing material:
 Cover glass fibre reinforced polyamide
 Lower part glass fibre reinforced polyamide
 Valve plate glass fibre reinforced polyamide

Components:
 Spring spring steel
 Oil dipstick stainless steel

Sealing material: NBR

Filter cartridge material:
 Sm-L glass fibre
 Mic cellulose
 Mol coalescence material
 MBL meltblown

Valve opening pressure:
 Inlet 0.03 bar
 Outlet 0.20 bar
 0.35 bar
 0.50 bar
 0.70 bar
 1.00 bar

Connection thread: G 3/4
 M42x2 *
 M30x1.5 *
 NPT 3/4 *
Connection flange: DIN *

Resistance: all HLP and HETG
 hydraulic oils **

* on request
 ** other oil types on request

We would like to point out that all values indicated are average values which do not always occur in specific cases of application. Our products are continually being further developed. Values, dimensions and weights can change as a result of this. Our specialist department would be pleased to offer you advice.

We recommend you contact us concerning applications for our filters in areas governed by the EU Directive 94/9 EC (ATEX 95). The standard version can be used for liquids based on mineral oil (corresponding to the fluids in Group 2 of Directive 97/23 EC Article 9). Please contact us if you intend using other media.

Subject to technical alteration without notice.

6. Type number key

Type number key with selection example for Pi 0201/Mic/0065/Z3/VV-0.2/P210/E*					
Series					
Pi 0201					
Filter medium					
Sm-L	glass fibre				
Mic	cellulose				
Mol	coalescence material				
MBL	meltblown				
Air flow rate					
0001	10 l/min				
0010	100 l/min				
0100	1000 l/min				
1000	10000 l/min				
9999	99990 l/min				
Connection code and dimension					
Z	inch				
3	G $\frac{3}{4}$ "	M22x1.5	NPT $\frac{3}{4}$ "	3 hole DIN xxxxx	
Valve					
VV-x.x	Preloaded valve with opening pressure x.x bar				
Optionen					
Pxxx	dipstick of length xxx mm				
Pi 0201	/Mic	/0065	/Z3	/VV-0.2	/P210

7. Order numbers

Complete filter												
Order number	Type designation	Filter cartridge				Air flow rate [l/min]	Switching pressure [mbar] Preloaded valve OFF					Preloaded valve ON >100 mbar
		Mic	MBL	Sm-L	Mol		200	350	500	700	1000	
72343041	Pi 0201/MIC/0050/Z3					500						
72399885	Pi 0201/MIC/0050/Z3/P210					500						
72343037	Pi 0201/MIC/0040/Z3/VV-0.2					400						
72397581	Pi 0201/MIC/0040/Z3/VV-0.35					400						
72399887	Pi 0201/MIC/0040/Z3/VV-0.35/P210					400						
72397583	Pi 0201/MBL/0050/Z3					500						
72399889	Pi 0201/MBL/0050/Z3/P210					500						
72397584	Pi 0201/MBL/0040/Z3/VV-0.2					400						
72397585	Pi 0201/MBL/0040/Z3/VV-0.35					400						
72399890	Pi 0201/MBL/0040/Z3/VV-0.35/P210					400						
72343044	Pi 0201/SML/0040/Z3					400						
72399891	Pi 0201/SML/0040/Z3/P210					400						
70594082	Pi 0201/SML/0035/Z3/VV-0.2					350						
72397586	Pi 0201/SML/0035/Z3/VV-0.35					350						
72399892	Pi 0201/SML/0035/Z3/VV-0.35/P210					350						
72397588	Pi 0201/MOL/0025/Z3					250						
72399893	Pi 0201/MOL/0025/Z3/P210					250						
72397589	Pi 0201/MOL/0020/Z3/VV-0.2					200						
72397590	Pi 0201/MOL/0020/Z3/VV-0.35					200						
72399894	Pi 0201/MOL/0020/Z3/VV-0.35/P210					200						

The FGC Pi 0201 series can replace almost all air breather filters from other manufacturers with a screw thread or connection flange in accordance with DIN 24557 without any problem. Please contact us.

Other versions and features on request.

Your Contact

FILCOM GmbH
Schönbuchstr. 1
D-73760 Ostfildern

Phone: +49 (0) 711-4413322-0
Fax: +49 (0) 711-4413322-22
Mail: info@filcom.de

www.filcom.de

FILCOM[®]
FILTRATION